

Ratcheting Box

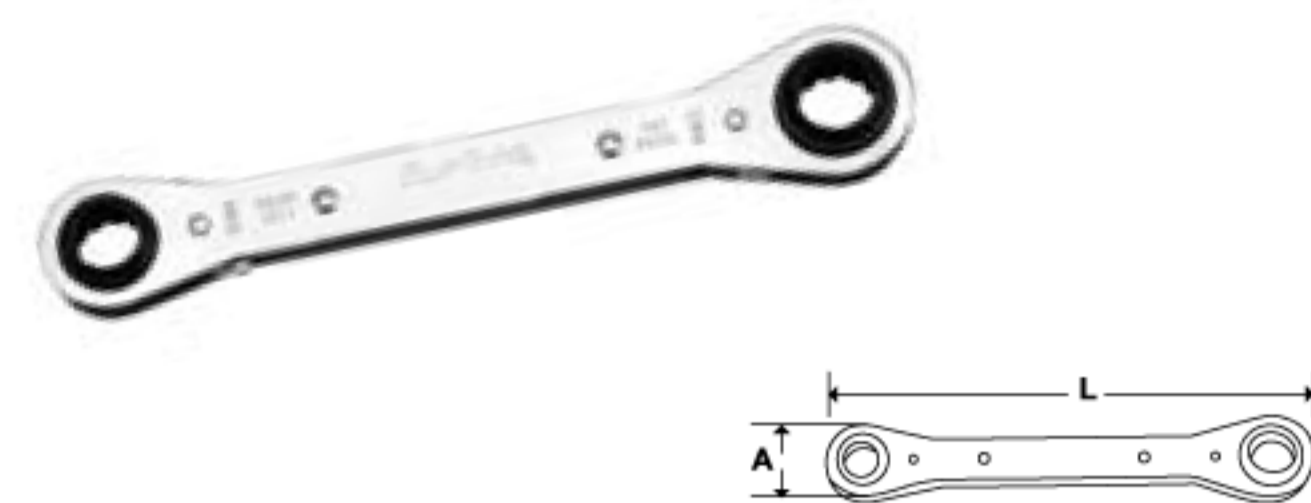

Stock No.	mm	A (mm)	L (mm)	Order No.
RBZM78	7-8	15.1-17.1	114	406112
RBZM910	9-10	20.4-22.6	140	406113
RBZM1112	11-12	25.8-29.4	175	406114
RBZM1314	13-14	25.8-29.4	175	406115
RBZM1517	15-17	32.9-36.5	206	406116
RBZM1618	16-18	32.9-36.5	206	406117
RBZM1921	19-21	35.7-40.1	235	406118

Ratcheting Box



Stock No.	mm	A (inches)	L (inches)	Order No.
RBZ810	1/4-5/16	3/8	4 1/2	406119
RBZ1214	3/8-7/16	3/8	5 7/2	406120
RBZ1618	1/2-9/16	1/2	6 1/8	406121
RBZ2022	5/8-11/16	1/2	9 1/4	406122
RBZ2428	3/4-7/8	1/2	9 1/4	406123

Locking Flex Head Ratchet

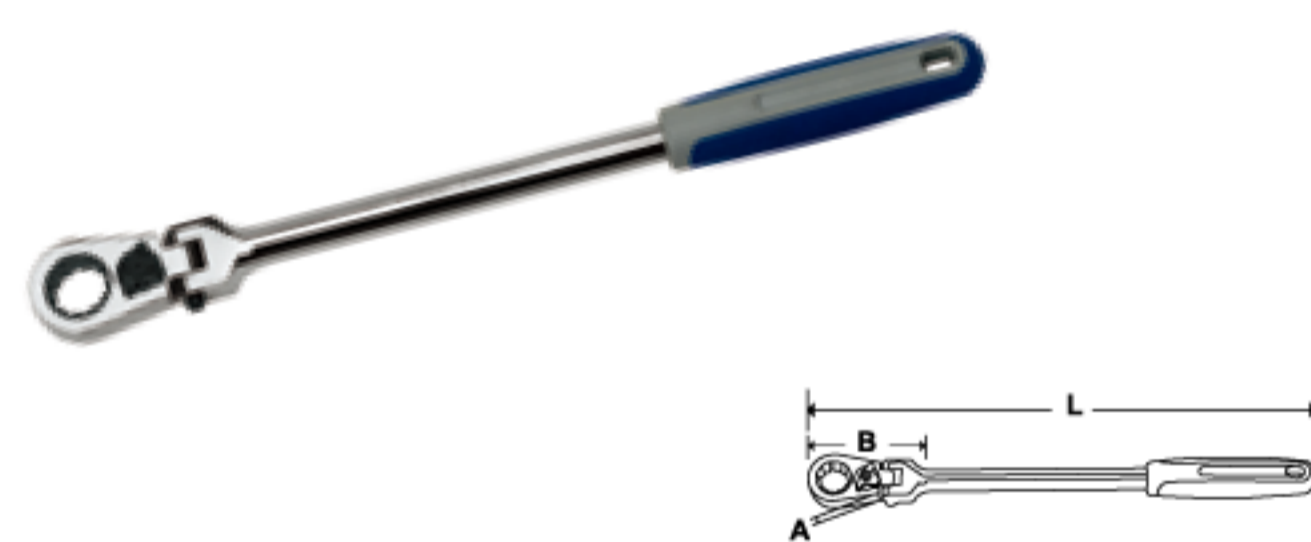

Stock No.	mm	A (mm)	B (mm)	L (mm)	Order No.
BOERFLCG8	8	6.55	32	228	406092
BOERFLCG9	9	7.45	34	229	406093
BOERFLCG10	10	8.05	38	233	406094
BOERFLCG11	11	8.55	40	235	406095
BOERFLCG12	12	9.05	42	285	406096
BOERFLCG13	13	10.05	45	287	406097
BOERFLCG14	14	10.05	48	289	406098
BOERFLCG15	15	11.05	52	293	406099
BOERFLCG16	16	11.05	54	347	406100
BOERFLCG17	17	12.05	56	348	406101
BOERFLCG18	18	12.05	60	352	406102
BOERFLCG19	19	12.95	64	354	406103

Locking Flex Head Ratchet

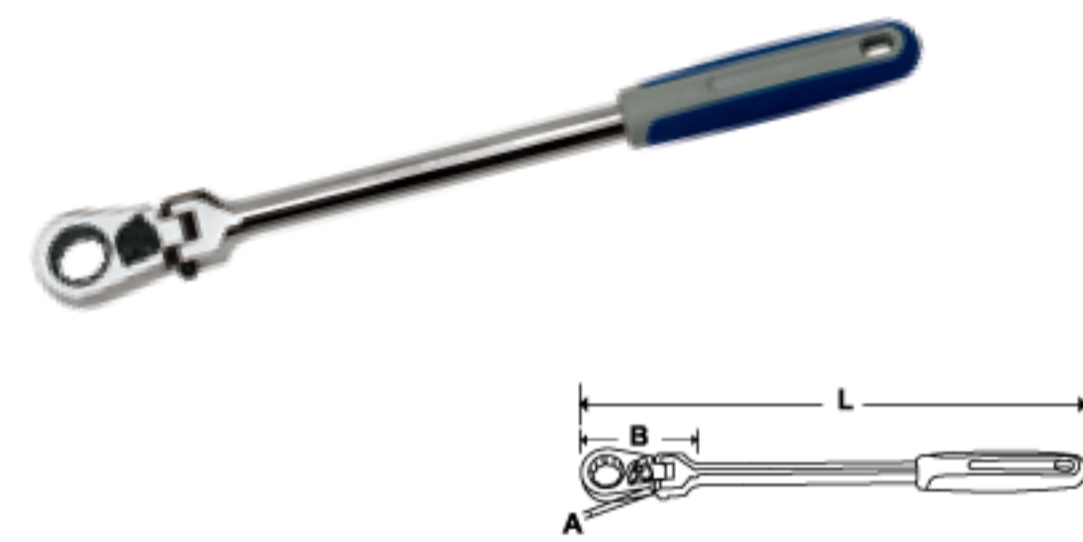

Stock No.	mm	A (inches)	B (inches)	L (inches)	Order No.
BOERFLCG10	5/16	1/4	1 1/4	9	406104
BOERFLCG12	3/8	5/16	1 1/2	8 1/4	406105
BOERFLCG14	7/16	11/32	1 9/16	9 19/32	406106
BOERFLCG16	1/2	13/32	1 25/32	11 9/32	406107
BOERFLCG18	9/16	13/32	1 29/32	11 3/8	406108
BOERFLCG20	5/8	7/16	2 1/8	13 21/32	406109
BOERFLCG22	11/16	15/32	2 7/32	13 23/32	406110
BOERFLCG24	3/4	1/2	2 17/32	13 15/16	406111

- Corrosive resistant bi-mold cushion grips for improved comfort and performance
- Wrenches have multiple locking head positions for easier access to tough to reach fasteners
- Long reach solid shank steel handle for improved reach and leverage
- Dual pawl reversible ratchet head
- Flex head pivots 90 degrees in either direction

L-Shape Hex Keys



Stock No.	mm	A (mm)	L (mm)	Order No.
BLWM12	12	44	209	407002
BLWM14	14	54.5	233	407003
BLWM17	17	61.5	276	407004
BLWM19	19	68.5	276	407005

- Made from high torque steel
- Heavy duty usage
- Satin finish

T-Shape Hex Keys



Stock No.	mm	A (mm)	L (mm)	Order No.
BTWM1.5	1.5	83	122	407007
BTWM2.5	2.5	83	122	407008
BTWM3	3	83	122	407009
BTWM4	4	83	122	407010
BTWM5	5	83	122	407011
BTWM6	6	134	186	407012
BTWM7	7	134	186	407013
BTWM8	8	134	186	407014

- Ergonomical handle for a better grip
- Made from high torque steel

T-Shape Speeder Wrench

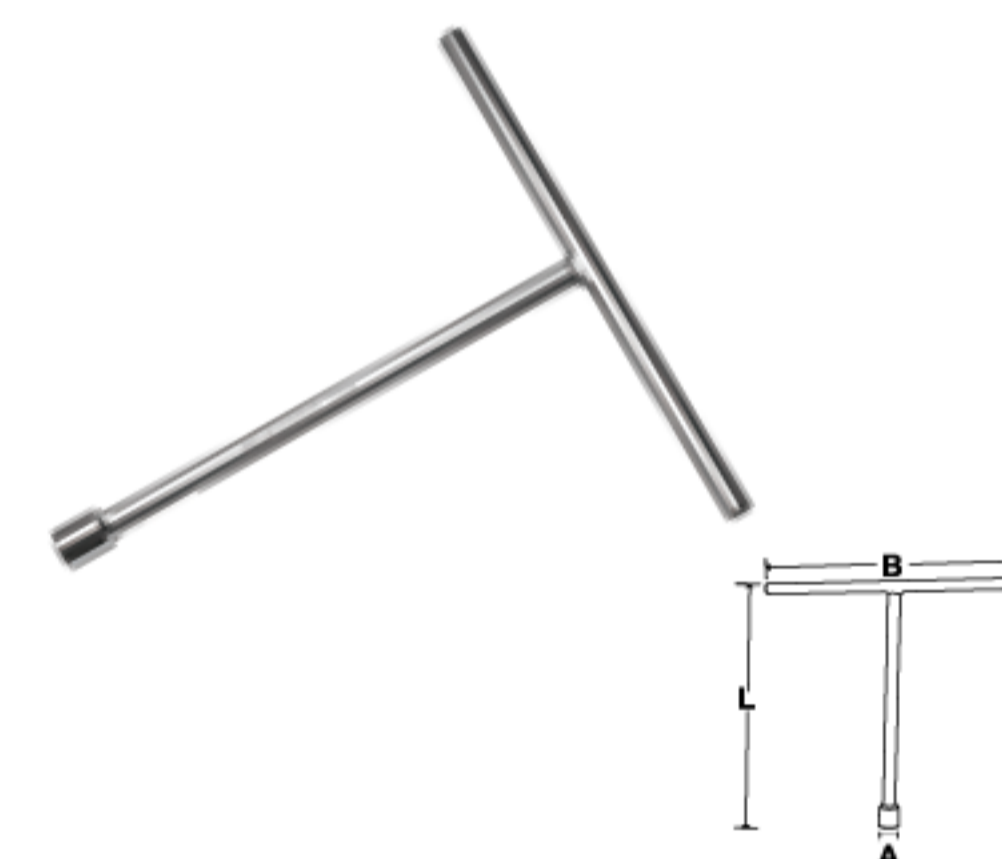

Stock No.	A (mm)	B (mm)	L (mm)	Order No.
BPTHM08	8	200	250	407015
BPTHM09	9	200	250	407016
BPTHM10	10	200	250	407017
BPTHM11	11	200	250	407018
BPTHM12	12	250	250	407019
BPTHM13	13	250	300	407020
BPTHM14	14	250	300	407021

- Speedy socket wrench, convenience for use
- Magnetic inset for convenience

Chain Wrench



Stock No.	Chain Length (inches)	Capacity (inches)	Handle Length (inches)	Order No.
CW12A	16	4	12	408001
CW15A	19	5	15	408002
CW24A	23	6	24	408003

Strap Wrench



Stock No.	Diameter	Order No.
BLPSTWR4	4" max	408005
BLPSTWR6	6" max	408006

- Adjusts to fit any circumference or irregular shape
- Grip, loosen or tighten almost anything
- Won't scratch or damage surfaces
- Cushioned grip for maximum comfort
- Heavy duty construction for longer life
- **BLPSTWRKT** (Order No.408004)**Set includes** BLPSTWR4 & BLPSTWR6

Ratcheting Box

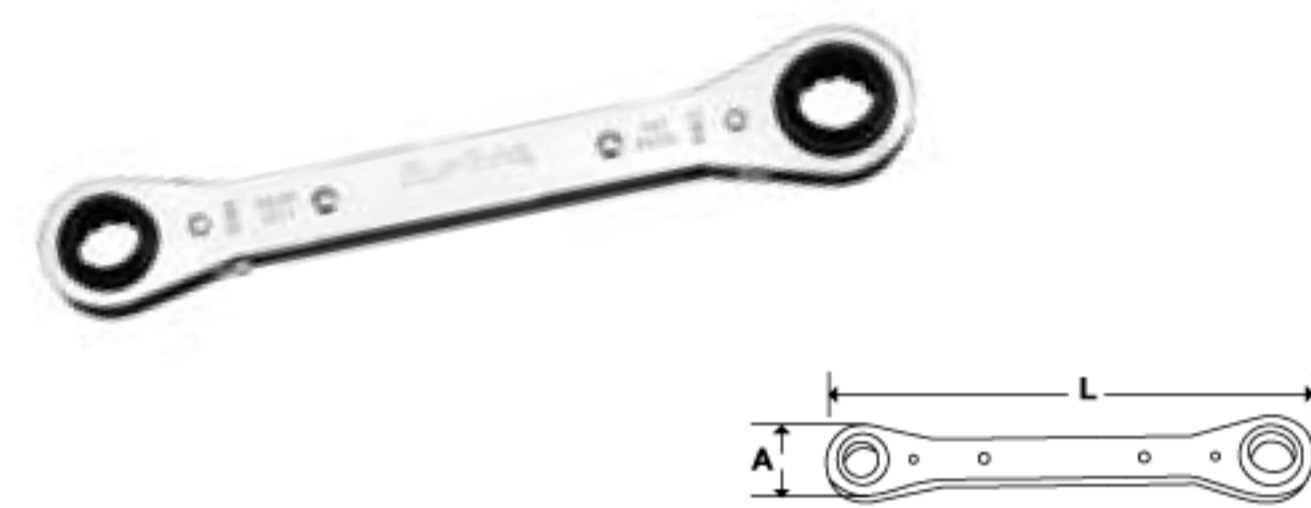

Stock No.	mm	A (mm)	L (mm)	Order No.
RBZM78	7-8	15.1-17.1	114	406112
RBZM910	9-10	20.4-22.6	140	406113
RBZM1112	11-12	25.8-29.4	175	406114
RBZM1314	13-14	25.8-29.4	175	406115
RBZM1517	15-17	32.9-36.5	206	406116
RBZM1618	16-18	32.9-36.5	206	406117
RBZM1921	19-21	35.7-40.1	235	406118

Ratcheting Box



Stock No.	mm	A (inches)	L (inches)	Order No.
RBZ810	1/4-5/16	3/8	4 1/2	406119
RBZ1214	3/8-7/16	3/8	5 1/2	406120
RBZ1618	1/2-9/16	1/2	6 1/8	406121
RBZ2022	5/8-11/16	1/2	9 1/4	406122
RBZ2428	3/4-7/8	1/2	9 1/4	406123

Locking Flex Head Ratchet

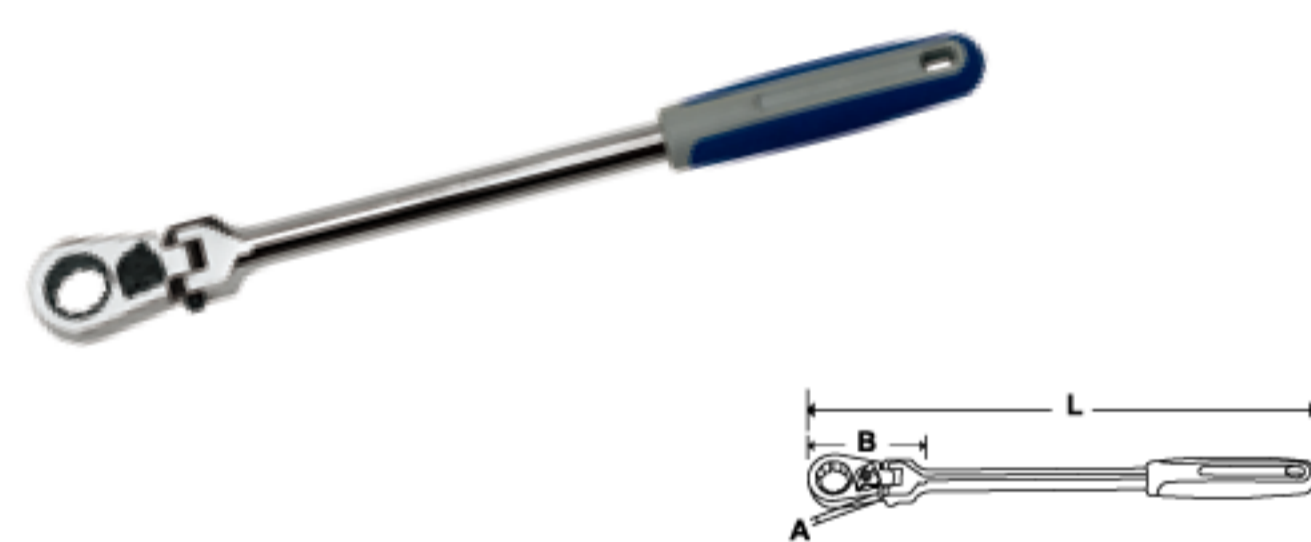

Stock No.	mm	A (mm)	B (mm)	L (mm)	Order No.
BOERFLCG8	8	6.55	32	228	406092
BOERFLCG9	9	7.45	34	229	406093
BOERFLCG10	10	8.05	38	233	406094
BOERFLCG11	11	8.55	40	235	406095
BOERFLCG12	12	9.05	42	285	406096
BOERFLCG13	13	10.05	45	287	406097
BOERFLCG14	14	10.05	48	289	406098
BOERFLCG15	15	11.05	52	293	406099
BOERFLCG16	16	11.05	54	347	406100
BOERFLCG17	17	12.05	56	348	406101
BOERFLCG18	18	12.05	60	352	406102
BOERFLCG19	19	12.95	64	354	406103

Locking Flex Head Ratchet

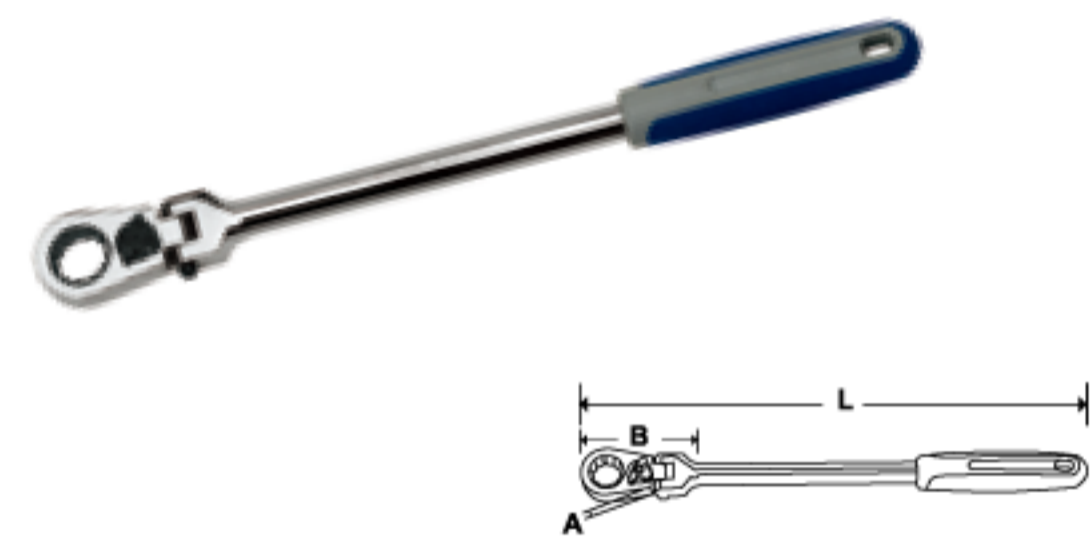

Stock No.	mm	A (inches)	B (inches)	L (inches)	Order No.
BOERFLCG10	5/16	1/4	1 1/4	9	406104
BOERFLCG12	3/8	5/16	1 1/2	8 1/4	406105
BOERFLCG14	7/16	11/32	1 9/16	9 19/32	406106
BOERFLCG16	1/2	13/32	1 25/32	11 9/32	406107
BOERFLCG18	9/16	13/32	1 29/32	11 3/8	406108
BOERFLCG20	5/8	7/16	2 1/8	13 21/32	406109
BOERFLCG22	11/16	15/32	2 7/32	13 23/32	406110
BOERFLCG24	3/4	1/2	2 17/32	13 15/16	406111

- Corrosive resistant bi-mold cushion grips for improved comfort and performance
- Wrenches have multiple locking head positions for easier access to tough to reach fasteners
- Long reach solid shank steel handle for improved reach and leverage
- Dual pawl reversible ratchet head
- Flex head pivots 90 degrees in either direction

L-Shape Hex Keys



Stock No.	mm	A (mm)	L (mm)	Order No.
BLWM12	12	44	209	407002
BLWM14	14	54.5	233	407003
BLWM17	17	61.5	276	407004
BLWM19	19	68.5	276	407005

- Made from high torque steel
- Heavy duty usage
- Satin finish

T-Shape Hex Keys



Stock No.	mm	A (mm)	L (mm)	Order No.
BTWM1.5	1.5	83	122	407007
BTWM2.5	2.5	83	122	407008
BTWM3	3	83	122	407009
BTWM4	4	83	122	407010
BTWM5	5	83	122	407011
BTWM6	6	134	186	407012
BTWM7	7	134	186	407013
BTWM8	8	134	186	407014

- Ergonomical handle for a better grip
- Made from high torque steel

T-Shape Speeder Wrench



Stock No.	A (mm)	B (mm)	L (mm)	Order No.
BPTHM08	8	200	250	407015
BPTHM09	9	200	250	407016
BPTHM10	10	200	250	407017
BPTHM11	11	200	250	407018
BPTHM12	12	250	250	407019
BPTHM13	13	250	300	407020
BPTHM14	14	250	300	407021

- Speedy socket wrench, convenience for use
- Magnetic inset for convenience

Chain Wrench



Stock No.	Chain Length (inches)	Capacity (inches)	Handle Length (inches)	Order No.
CW12A	16	4	12	408001
CW15A	19	5	15	408002
CW24A	23	6	24	408003

Strap Wrench



Stock No.	Diameter	Order No.
BLPSTWR4	4" max	408005
BLPSTWR6	6" max	408006

- Adjusts to fit any circumference or irregular shape
- Grip, loosen or tighten almost anything
- Won't scratch or damage surfaces
- Cushioned grip for maximum comfort
- Heavy duty construction for longer life
- **BLPSTWRKT** (Order No.408004)**Set includes** BLPSTWR4 & BLPSTWR6